

# S.101

The ideal choice for medium weight transportation.  
Spiral Coolers, Radius Conveyors.  
FDA approved.



**SCANBELT**  
...keeping industry moving...

## SUGGESTED INDUSTRIES



## STANDARD FEATURES

Belt surface	Smooth
Open area	52 %
Strength	The ideal choice for medium-duty transportation
Cleanability	Good
Width interval	Normally 20 mm. E.g: 210 mm, 230 mm etc.

## BELT DATA

Belt materials	Temperature		Rods	Max. belt pull kg/m	Belt weight kg/m <sup>2</sup>	Standard Colours
	Min.	Max.				
PP	+ 5	100	PP	60	4,5	White/Blue
			Nylon	90	4,5	
			Steel	90	10	
POM	- 43	95	PP	75	7	Natural/Blue
			Nylon	120	7	
			Steel	120	12,5	

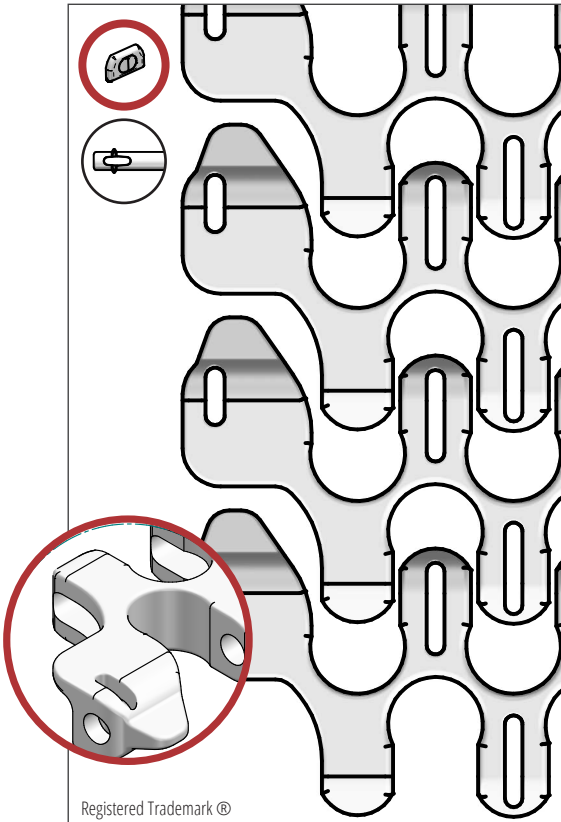

Registered Trademark ©

## ACCESSORIES

Type	mm
Flights	25, 50, 75
Side Guard	-
Friction Top	Yes
Hooks or Tabs	Yes

## SPROCKET ENGAGEMENT

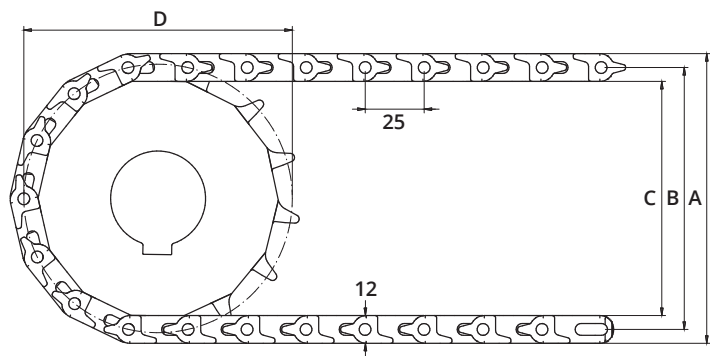
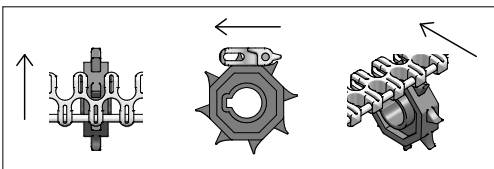

## SPROCKET DATA

A = Outside, B = Pitch, C = Inside, D = Pitch Circle Diameter

No. Teeth	A	B	C	D	Hub Width	Round Bore		Square Bore	
	mm	mm	mm	mm		mm	Inch	mm	Inch
8	74	62	50	66	20	20 / 25	¾ / 1	25	
12	106	94	82	98	20	20 / 25 / 30 / 40	¾ / 1 / 1¼	25 / 40	1½
20	173	161	149	162	35	25 / 30 / 40	1 / 1¼	25 / 40	1½

# S.101 BELT DIMENSIONS

S. 101-25 mm radius.

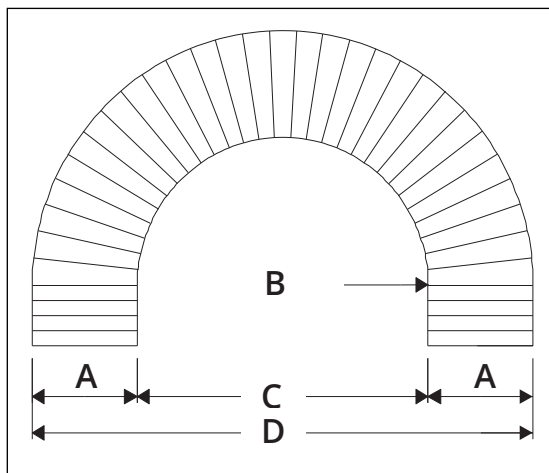

<b>A</b>	107	210	292	394	497	600	702	805	907	1011
<b>B</b>	150	300	450	650	850	1035	1250	1460	1680	1905
<b>C</b>	300	600	900	1300	1700	2070	2500	2920	3360	3810
<b>D</b>	514	1020	1484	2088	2994	3270	3904	4530	5174	5832

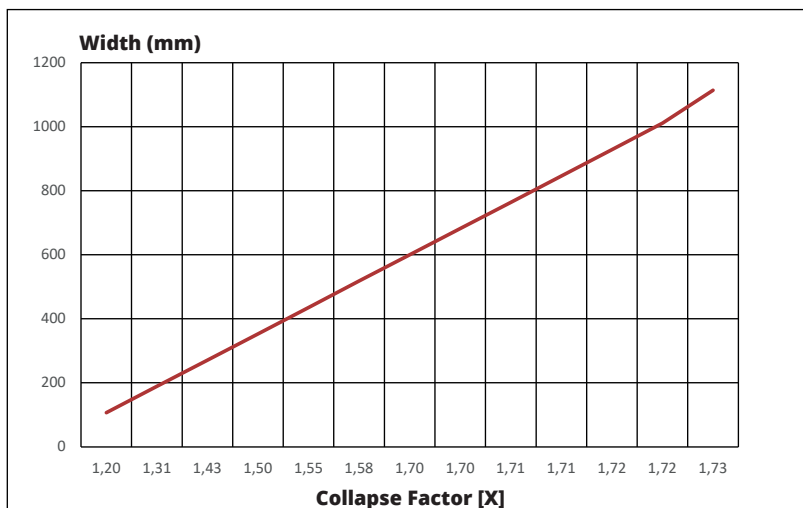

**Collapse factor =  $\frac{\text{min. inner radius}}{\text{belt width}}$**

Min. inner radius = collapse factor x belt width

**Collapse factor from 1,4**

## STANDARD WIDTH

Belt width.	Min.inner radius.	Belt width.	Min.inner radius
107	150	600	1035
128	180	620	1075
148	210	641	1115
169	240	662	1160
189	270	682	1205
210	300	702	1250
230	330	723	1290
251	370	744	1330
271	410	764	1370
292	450	785	1415
312	490	805	1460
333	530	826	1505
353	570	846	1550
374	610	867	1595
394	650	887	1635
414	690	907	1680
435	730	928	1725
455	770	949	1770
477	810	970	1815
497	850	990	1860
518	885	1011	1905
538	920	1114	2125
559	960	1217	2350
579	1000	1320	2595

# S.101 HOOK MEASUREMENT

## S. 101 Turned inside

### S.101 – DISTANCE FOR HOOKS TURNED INSIDE – (MM)

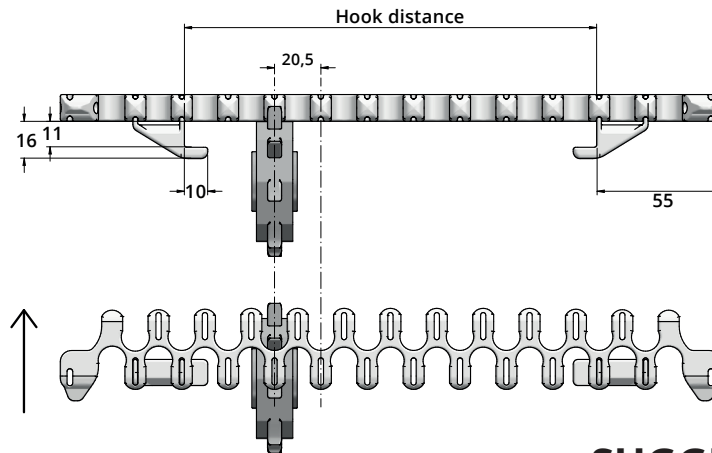

### SUGGESTED MODEL

128	
148	38
168	- 59
189	38 - 79
210	- 59 - 100
230	38 - 79 - 120
251	- 59 - 100 - 141
271	38 - 79 - 120 - 161
292	- 59 - 100 - 141 - 182
312	38 - 79 - 120 - 161 - 202
333	- 59 - 100 - 141 - 182 - 223
353	38 - 79 - 120 - 161 - 202 - 243
374	- 59 - 100 - 141 - 182 - 223 - 264
394	38 - 79 - 120 - 161 - 202 - 243 - 284
414	- 59 - 100 - 141 - 182 - 223 - 264 - 304
435	38 - 79 - 120 - 161 - 202 - 243 - 284 - 325
455	- 59 - 100 - 141 - 182 - 223 - 264 - 304 - 345
477	38 - 79 - 120 - 161 - 202 - 243 - 284 - 325 - 367
497	- 59 - 100 - 141 - 182 - 223 - 264 - 304 - 345 - 387
518	38 - 79 - 120 - 161 - 202 - 243 - 284 - 325 - 367 - 408
538	- 59 - 100 - 141 - 182 - 223 - 264 - 304 - 345 - 387 - 428
559	38 - 79 - 120 - 161 - 202 - 243 - 284 - 325 - 367 - 408 - 449
579	- 59 - 100 - 141 - 182 - 223 - 264 - 304 - 345 - 387 - 428 - 469
600	38 - 79 - 120 - 161 - 202 - 243 - 284 - 325 - 367 - 408 - 449 - 490
620	- 59 - 100 - 141 - 182 - 223 - 264 - 304 - 345 - 387 - 428 - 469 - 510
641	38 - 79 - 120 - 161 - 202 - 243 - 284 - 325 - 367 - 408 - 449 - 490 - 531
662	- 59 - 100 - 141 - 182 - 223 - 264 - 304 - 345 - 387 - 428 - 469 - 510 - 552
682	38 - 79 - 120 - 161 - 202 - 243 - 284 - 325 - 367 - 408 - 449 - 490 - 531 - 572
702	- 59 - 100 - 141 - 182 - 223 - 264 - 304 - 345 - 387 - 428 - 469 - 510 - 552 - 592
723	38 - 79 - 120 - 161 - 202 - 243 - 284 - 325 - 367 - 408 - 449 - 490 - 531 - 572 - 613
744	- 59 - 100 - 141 - 182 - 223 - 264 - 304 - 345 - 387 - 428 - 469 - 510 - 552 - 592 - 634
764	38 - 79 - 120 - 161 - 202 - 243 - 284 - 325 - 367 - 408 - 449 - 490 - 531 - 572 - 613 - 654
785	- 59 - 100 - 141 - 182 - 223 - 264 - 304 - 345 - 387 - 428 - 469 - 510 - 552 - 592 - 634 - 675
805	38 - 79 - 120 - 161 - 202 - 243 - 284 - 325 - 367 - 408 - 449 - 490 - 531 - 572 - 613 - 654 - 695
826	- 59 - 100 - 141 - 182 - 223 - 264 - 304 - 345 - 387 - 428 - 469 - 510 - 552 - 592 - 634 - 675 - 716
846	38 - 79 - 120 - 161 - 202 - 243 - 284 - 325 - 367 - 408 - 449 - 490 - 531 - 572 - 613 - 654 - 695 - 736
867	- 59 - 100 - 141 - 182 - 223 - 264 - 304 - 345 - 387 - 428 - 469 - 510 - 552 - 592 - 634 - 675 - 716 - 757
887	38 - 79 - 120 - 161 - 202 - 243 - 284 - 325 - 367 - 408 - 449 - 490 - 531 - 572 - 613 - 654 - 695 - 736 - 777
907	- 59 - 100 - 141 - 182 - 223 - 264 - 304 - 345 - 387 - 428 - 469 - 510 - 552 - 592 - 634 - 675 - 716 - 757 - 797
928	38 - 79 - 120 - 161 - 202 - 243 - 284 - 325 - 367 - 408 - 449 - 490 - 531 - 572 - 613 - 654 - 695 - 736 - 777 - 818
949	- 59 - 100 - 141 - 182 - 223 - 264 - 304 - 345 - 387 - 428 - 469 - 510 - 552 - 592 - 634 - 675 - 716 - 757 - 797 - 839
970	38 - 79 - 120 - 161 - 202 - 243 - 284 - 325 - 367 - 408 - 449 - 490 - 531 - 572 - 613 - 654 - 695 - 736 - 777 - 818 - 860
990	- 59 - 100 - 141 - 182 - 223 - 264 - 304 - 345 - 387 - 428 - 469 - 510 - 552 - 592 - 634 - 675 - 716 - 757 - 797 - 839 - 880
1011	38 - 79 - 120 - 161 - 202 - 243 - 284 - 325 - 367 - 408 - 449 - 490 - 531 - 572 - 613 - 654 - 695 - 736 - 777 - 818 - 860 - 901
	- 59 - 100 - 141 - 182 - 223 - 246 - 304 - 345 - 387 - 428 - 469 - 510 - 552 - 592 - 634 - 675 - 716 - 757 - 797 - 839 - 808 -

Hook Distance

# S.101 HOOK MEASUREMENT

S. 101 Turned outside

## S.101 – DISTANCE FOR HOOKS TURNED OUTSIDE - (MM)

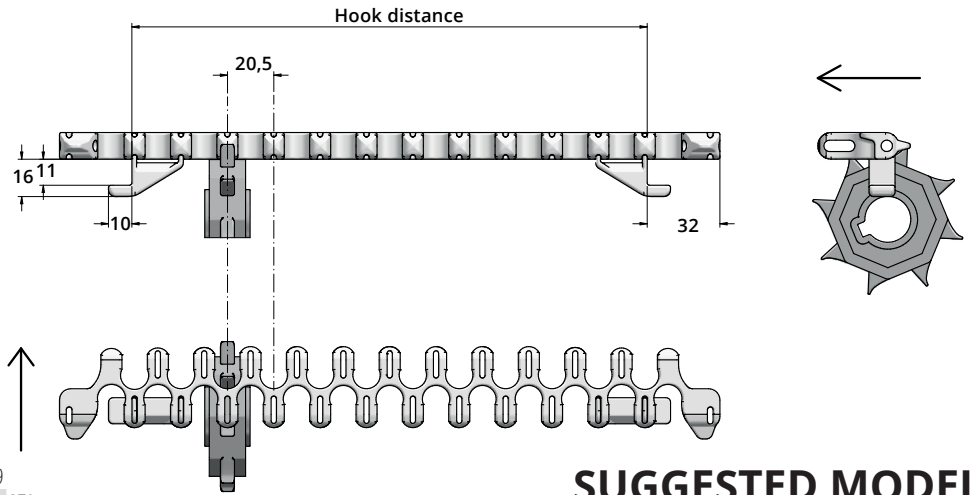

**SUGGESTED MODEL**

Belt Distance	Hook Distance
128	64
148	- 84
168	64 - 105
189	- 84 - 125
210	64 - 105 - 146
230	- 84 - 125 - 167
251	64 - 105 - 146 - 188
271	- 84 - 125 - 167 - 208
292	64 - 105 - 146 - 188 - 229
312	- 84 - 125 - 167 - 208 - 249
333	64 - 105 - 146 - 188 - 229 - 270
353	- 84 - 125 - 167 - 208 - 249 - 290
374	64 - 105 - 146 - 188 - 229 - 270 - 311
394	- 84 - 125 - 167 - 208 - 249 - 290 - 331
414	64 - 105 - 146 - 188 - 229 - 270 - 311 - 351
435	- 84 - 125 - 167 - 208 - 249 - 290 - 331 - 372
455	64 - 105 - 146 - 188 - 229 - 270 - 311 - 351 - 392
477	- 84 - 125 - 167 - 208 - 249 - 290 - 331 - 372 - 413
497	64 - 105 - 146 - 188 - 229 - 270 - 311 - 351 - 392 - 433
518	- 84 - 125 - 167 - 208 - 249 - 290 - 331 - 372 - 413 - 454
538	64 - 105 - 146 - 188 - 229 - 270 - 311 - 351 - 392 - 433 - 474
559	- 84 - 125 - 167 - 208 - 249 - 290 - 331 - 372 - 413 - 454 - 495
579	64 - 105 - 146 - 188 - 229 - 270 - 311 - 351 - 392 - 433 - 474 - 515
600	- 84 - 125 - 167 - 208 - 249 - 290 - 331 - 372 - 413 - 454 - 495 - 536
620	64 - 105 - 146 - 188 - 229 - 270 - 311 - 351 - 392 - 433 - 474 - 515 - 556
641	- 84 - 125 - 167 - 208 - 249 - 290 - 331 - 372 - 413 - 454 - 495 - 536 - 577
662	64 - 105 - 146 - 188 - 229 - 270 - 311 - 351 - 392 - 433 - 474 - 515 - 556 - 598
682	- 84 - 125 - 167 - 208 - 249 - 290 - 331 - 372 - 413 - 454 - 495 - 536 - 577 - 618
702	64 - 105 - 146 - 188 - 229 - 270 - 311 - 351 - 392 - 433 - 474 - 515 - 556 - 598 - 638
723	- 84 - 125 - 167 - 208 - 249 - 290 - 331 - 372 - 413 - 454 - 495 - 536 - 577 - 618 - 659
744	64 - 105 - 146 - 188 - 229 - 270 - 311 - 351 - 392 - 433 - 474 - 515 - 556 - 598 - 638 - 680
764	- 84 - 125 - 167 - 208 - 249 - 290 - 331 - 372 - 413 - 454 - 495 - 536 - 577 - 618 - 659 - 700
785	64 - 105 - 146 - 188 - 229 - 270 - 311 - 351 - 392 - 433 - 474 - 515 - 556 - 598 - 638 - 680 - 721
805	- 84 - 125 - 167 - 208 - 249 - 290 - 331 - 372 - 413 - 454 - 495 - 536 - 577 - 618 - 659 - 700 - 741
826	64 - 105 - 146 - 188 - 229 - 270 - 311 - 351 - 392 - 433 - 474 - 515 - 556 - 598 - 638 - 680 - 721 - 762
846	- 84 - 125 - 167 - 208 - 249 - 290 - 331 - 372 - 413 - 454 - 495 - 536 - 577 - 618 - 659 - 700 - 741 - 782
867	64 - 105 - 146 - 188 - 229 - 270 - 311 - 351 - 392 - 433 - 474 - 515 - 556 - 598 - 638 - 680 - 721 - 762 - 803
887	- 84 - 125 - 167 - 208 - 249 - 290 - 331 - 372 - 413 - 454 - 495 - 536 - 577 - 618 - 659 - 700 - 741 - 782 - 823
907	64 - 105 - 146 - 188 - 229 - 270 - 311 - 351 - 392 - 433 - 474 - 515 - 556 - 598 - 638 - 680 - 721 - 762 - 803 - 843
928	- 84 - 125 - 167 - 208 - 249 - 290 - 331 - 372 - 413 - 454 - 495 - 536 - 577 - 618 - 659 - 700 - 741 - 782 - 823 - 864
949	64 - 105 - 146 - 188 - 229 - 270 - 311 - 351 - 392 - 433 - 474 - 515 - 556 - 598 - 638 - 680 - 721 - 762 - 803 - 843 - 884
970	- 84 - 125 - 167 - 208 - 249 - 290 - 331 - 372 - 413 - 454 - 495 - 536 - 577 - 618 - 659 - 700 - 741 - 782 - 823 - 864 - 906
990	64 - 105 - 146 - 188 - 229 - 270 - 311 - 351 - 392 - 433 - 474 - 515 - 556 - 598 - 638 - 680 - 721 - 762 - 803 - 843 - 884 - 926
1011	- 84 - 125 - 167 - 208 - 249 - 290 - 331 - 372 - 413 - 454 - 495 - 536 - 577 - 618 - 659 - 700 - 741 - 782 - 823 - 864 - 906 - 947
64	- 105 - 146 - 188 - 229 - 270 - 311 - 351 - 392 - 433 - 474 - 515 - 556 - 598 - 638 - 680 - 721 - 762 - 803 - 843 - 884 - 926 -

Hook Distance